

# Refractive Index measurements (e.g. density)

## Contents

### Waves in a plasma

- wave representation

- group velocity

- index of refraction

- polarization

- small amplitude variations

- some elementary waves in plasmas

- em waves with  $B_0 = 0$  in vacuum.

- dielectric properties of plasmas

- em waves with  $B_0 = 0$  in a plasma

- including a magnetic field

  - O mode

  - X mode

  - Cutoffs and resonances

### General em waves in plasmas

Electron density measurements in the earth's ionosphere.

### The interferometer

- Michelson

- Mach Zender

- Fabry Perot

- simple analysis

- determining the phase shift

- modulation and detection

- coherence, diffraction, refraction

- frequency choice

### Abel inversion

### Interference imaging

### Schlieren and shadowgraphs

### Faraday rotation

### Reflectometry

### Physical optics and Fourier analysis

### Phase contrast imaging

# 1. Waves in a Plasma

## Wave Representation

A plane wave is one whose direction of propagation and amplitude is everywhere the same. Light or radio waves traveling through a plasma. Standard representation is:

$$n = \bar{n} \exp(i(\mathbf{k} \cdot \mathbf{r} - t))$$

where

$$\mathbf{k} \cdot \mathbf{r} = k_x x + k_y y + k_z z$$

$k$  is wave vector or propagation constant. Convention: exp. notation means real part of expression is the measurable quantity. If  $\bar{n}$  is real, and wave propagates in  $x$  direction only, then

$$\text{Re}(n) = \bar{n} \cos(kx - t).$$

A point of constant phase on the wave front moves so that  $(d/dt)[kx - t] = 0$

i.e.

$$\frac{dx}{dt} = \frac{1}{k} = v_{ph}$$

$k > 0$  then wave moves to the right, i.e.  $x$  increases to keep  $kx - t$  constant.

## Group velocity.

$v_{ph} > c$  is possible, as infinite wave train of constant amplitude carries no information until it is modulated. The modulation information does not travel at the phase velocity, but at the group velocity, and  $v_g < c$ .

Consider two beating waves

$$E_1 = E_0 \cos((k + k)x - ( + )t)$$

$$E_2 = E_0 \cos((k - k)x - ( - )t)$$

each wave must have the phase velocity  $v_{ph} = \omega/k$  appropriate to the medium. Therefore there must be a difference  $2k$  in the propagation constant.

Let

$$a = kx - \omega t$$

$$b = kx - \omega t$$

Then

$$E_1 + E_2 = E_0 \cos(a + b) + E_0 \cos(a - b)$$

$$= E_0 (\cos(a)\cos(b) - \sin(a)\sin(b) + \cos(a)\cos(b) + \sin(a)\sin(b))$$

$$= 2E_0 \cos(a)\cos(b)$$

$$E_1 + E_2 = 2E_0 \cos(kx - \omega t) \cos(kx - \omega t)$$

i.e. a sinusoidally modulated wave. The envelope of the wave is given by  $\cos[kx - \omega t]$  and travels at  $\omega / k$ . In the limit  $\omega \rightarrow 0$ , we have the group velocity. Same holds for a wave packet.

$$v_g = \frac{d\omega}{dk}$$

### Index of refraction

$$\mu = \frac{c}{v_{ph}} = \frac{ck}{\omega}$$

Generally it is frequency and wave number dependent. Propagation occurs only if the medium is transparent, and the refractive index is real. The group refractive index is used when considering wave packets, and

$$\mu_g = \frac{c}{v_g} = \frac{ck}{\omega + k \frac{d\omega}{dk}}$$

To see the relationship between the two refractive indices, note that

$$\frac{d\mu}{dk} = \frac{c}{\omega} - \frac{ck}{\omega^2} \frac{d\omega}{dk}$$

Solve this for  $\frac{d\omega}{dk}$ , and insert into definition of  $\mu_g$ , to give

$$\mu_g = \mu + \frac{\mu}{\mu - 1} \frac{d\mu}{dk}$$

$$v_g = \frac{c}{\mu + \frac{\mu}{\mu - 1} \frac{d\mu}{dk}}$$

## Polarization

Consider two waves which we can measure

$$\mathbf{E} = \text{Re } \mathbf{E}_0 \exp(i(\mathbf{k} \cdot \mathbf{r} - t))$$

$$\mathbf{B} = \text{Re } \mathbf{B}_0 \exp(i(\mathbf{k} \cdot \mathbf{r} - t))$$

$\mathbf{E}_0$  and  $\mathbf{B}_0$  are in general complex vectors. Write

$$\mathbf{E}_0 = A_0 e^{i\phi} = \mathbf{E}_1 + i\mathbf{E}_2$$

where  $A_0$  is a real vector. Now consider a wave propagating in the  $z$  direction. Then we can let

$$\mathbf{E}_1 = \hat{x}E_1 \sin \quad + \hat{y}E_2 \cos$$

$$\mathbf{E}_2 = -\hat{x}E_1 \cos \quad + \hat{y}E_2 \sin$$

A simple example. Let  $\phi = \pi/2$  so that

$$\mathbf{E}_1 = \hat{x}E_1$$

$$\mathbf{E}_2 = \hat{y}E_2$$

With this choice

$$E_0^2 = E_1^2 + E_2^2$$

$$E_x = E_1 \sin(\mathbf{k} \cdot \mathbf{r} - t)$$

$$E_y = E_2 \cos(\mathbf{k} \cdot \mathbf{r} - t)$$

$$\frac{E_y^2}{E_2^2} + \frac{E_x^2}{E_1^2} = 1$$

i.e. an ellipse. Thus for plane waves the  $E$  field at each point rotates in space at an angular frequency  $\omega$  in a plane perpendicular to the direction of propagation. Generally the tip of the vector describes an ellipse and the wave is elliptically polarized. An observer looking in the direction of propagation sees a clockwise sense of direction. If  $E_1 = E_2$  the wave is circularly polarized. If  $E_1$  or  $E_2 = 0$ , then the wave is linearly polarized.

## Small amplitude perturbations

$$\frac{\partial}{\partial t} - i \mathbf{k} \cdot \nabla$$

## Some elementary waves in plasmas:

Plasma oscillations

Electron plasma waves

Sound waves

Ion waves

Electrostatic electron oscillations perpendicular to  $B$

Electrostatic ion waves perpendicular to  $B$

Lower Hybrid frequency

em waves with  $B_0 = 0$

em waves perpendicular to  $B_0$

em waves parallel to  $B_0$

Hydromagnetic waves

Magnetosonic waves

## em waves with $B_0 = 0$ in vacuum

Review **vacuum case**. Ordinary light waves are transverse em waves in which  $k$  is perpendicular to both oscillating  $E$  and oscillating  $B$  of the wave. Maxwell

$$\begin{aligned} \nabla \times \mathbf{E} &= -\frac{\partial \mathbf{B}}{\partial t} \\ \nabla \times \mathbf{H} &= \mathbf{J} + \frac{\partial \mathbf{D}}{\partial t} \\ \nabla \cdot \mathbf{B} &= 0 \\ \nabla \cdot \mathbf{D} &= \rho_c \\ \mathbf{B} &= \mu \mathbf{H} \\ \mathbf{D} &= \epsilon \mathbf{E} \end{aligned}$$

with  $\mathbf{j} = 0$  and  $\epsilon_0 \mu_0 = c^2$  (vacuum)

$$\begin{aligned} \nabla \times \mathbf{E}_1 &= -\frac{\partial \mathbf{B}_1}{\partial t} \\ c^2 \nabla \times \mathbf{H}_1 &= \frac{\partial \mathbf{D}_1}{\partial t} \end{aligned}$$

take curl of second equation, substitute into time derivative of first, gives

$$\begin{aligned} \nabla \times \mathbf{E}_1 &= -\frac{\partial \mathbf{B}_1}{\partial t} \\ c^2 \nabla \times (\nabla \times \mathbf{H}_1) &= \nabla \times \frac{\partial \mathbf{D}_1}{\partial t} = -\frac{\partial^2 \mathbf{B}_1}{\partial t^2} \end{aligned}$$

Assume standard wave representation:

$$\nabla^2 \mathbf{B}_1 = -c^2 \mathbf{k} \times (\mathbf{k} \times \mathbf{B}_1) = -c^2 [\mathbf{k}(\mathbf{k} \cdot \mathbf{B}_1) - k^2 \mathbf{B}_1]$$

Now

$$\mathbf{k} \cdot \mathbf{B}_1 = -i \mathbf{k} \cdot \mathbf{B}_1 = 0$$

so

$$\nabla^2 \mathbf{B}_1 = k^2 c^2 \mathbf{B}_1$$

i.e. phase velocity =  $c$ . In a **plasma** the first of Maxwell's equations we have used is unchanged, but the second has a new component .

## Dielectric properties of a plasma

Plasma resembles a system of coupled oscillators. Define a polarization and magnetization vector

$$\begin{aligned} \mathbf{P} &= \mathbf{D} - \epsilon_0 \mathbf{E} \\ \mathbf{M} &= \frac{\mathbf{B}}{\mu_0} - \mathbf{H} \end{aligned}$$

These are only meaningful in a material (they vanish in free space). Substitute into Maxwell's equations to get

$$\begin{aligned} \nabla \times \mathbf{B} &= \mu_0 \mathbf{J}_T + \mu_0 \epsilon_0 \frac{\partial \mathbf{E}}{\partial t} \\ \nabla \cdot \mathbf{E} &= \frac{\rho_T}{\epsilon_0} \end{aligned}$$

where

$$\begin{aligned} \mathbf{J}_T &= \mathbf{J} + \frac{\partial \mathbf{P}}{\partial t} + \nabla \times \mathbf{M} \\ \rho_T &= \rho_{ext} - \nabla \cdot \mathbf{P} \end{aligned}$$

$\partial \mathbf{P} / \partial t$  is polarization current,  $\nabla \times \mathbf{M}$  is magnetization current,  $\nabla \cdot \mathbf{P}$  is polarization charge.  $\mathbf{J}$  and  $\rho_{ext}$  are external sources, while other terms are medium dependent. Now take curl of first of Maxwell's equations and use above to get

$$\nabla \times (\nabla \times \mathbf{E}) = \nabla \times \dot{\mathbf{B}} = -\mu_0 \dot{\mathbf{J}} - \frac{\ddot{\mathbf{E}}}{c^2}$$

where we have dropped subscript T on J (we are referring to total current). Then

$$-k \times (k \times \mathbf{E}_1) = i\mu_0 \mathbf{J}_1 + \frac{\partial^2 \mathbf{E}_1}{c^2}$$

### em waves with $\mathbf{B}_0 = 0$ in a plasma.

Expand LHS to get

$$k^2 \mathbf{E}_1 - (k \cdot \mathbf{E}_1) \mathbf{k} = i\mu_0 \mathbf{J}_1 + \frac{\partial^2 \mathbf{E}_1}{c^2}$$

Assume ions are at rest, so that the wave electric field drives the electrons into motion and produces the current

$$\mathbf{J}_1 = -en\mathbf{u}_1$$

The velocity  $\mathbf{u}_1$  is found for the  $B = 0$  case (or a case where  $\mathbf{u} \times \mathbf{B} = 0$ ) from the equation of motion

$$\mathbf{u}_1 = \frac{e\mathbf{E}_1}{im}$$

Then

$$k^2 \mathbf{E}_1 - (\mathbf{k} \cdot \mathbf{E}_1) \mathbf{k} = -\frac{\omega_p^2}{c^2} \mathbf{E}_1 + \frac{\omega^2}{c^2} \mathbf{E}_1$$

For waves with  $\mathbf{k} \cdot \mathbf{E}_1 = 0$  (transverse), we have

$$\omega^2 = \omega_p^2 + k^2 c^2$$

$$\omega_p = \sqrt{\frac{ne^2}{m_0}}$$

is the plasma frequency. Introducing plasma modifies the dispersion relationship because of the electron motion which is a current. The phase velocity is  $> c$ .

$$v_{ph} = \frac{\omega}{k} = c \sqrt{1 + \frac{\omega_p^2}{k^2 c^2}}$$

Group velocity is

$$v_g = \frac{d\omega}{dk} = \frac{kc^2}{\omega} = \frac{c^2}{v_{ph}}$$

(Always  $< c$  because  $c/v_{ph} < 1$ )

The index of refraction is

$$\mu = \frac{ck}{\omega} = \sqrt{1 - \frac{\omega_p^2}{\omega^2}}$$

If a wave of frequency  $\omega$  is sent into a plasma, the  $k$  vector (i.e. the wavelength  $\lambda = 2\pi/k$ ) will take on the value described above. Waves propagate only if  $\mu^2 > 0$ . i.e. we must have  $\omega > \omega_p$ . The cutoff frequency occurs at  $\omega = \omega_p$ . For waves with  $\omega < \omega_p$  the index of refraction is imaginary. If  $\mu$  is real then  $k$  is imaginary, which means the waves are attenuated. Let

$$\mathbf{k} = \mathbf{k}_R + i\mathbf{k}_I$$

Spatial dependencies become

$$e^{i\mathbf{k} \cdot \mathbf{r}} = e^{i\mathbf{k}_R \cdot \mathbf{r}} e^{-\mathbf{k}_I \cdot \mathbf{r}}$$

The skin depth is defined as

$$d = |\mathbf{k}_I|^{-1}$$

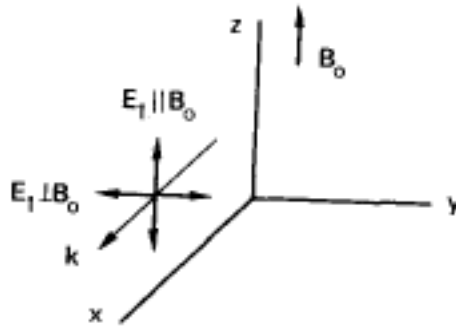
i.e.



$$d = \frac{c}{\sqrt{\frac{2}{p} - 2}}$$

### Including a magnetic field

Consider perpendicular propagation,  $\mathbf{k} \perp \mathbf{B}_0$ . Now take transverse waves, so that  $\mathbf{k} \perp \mathbf{E}_1$ . There are still two choices,  $\mathbf{E}_1$  can be parallel to  $\mathbf{B}_0$  or  $\mathbf{E}_1$  can be perpendicular to  $\mathbf{B}_0$ .



### Ordinary Wave

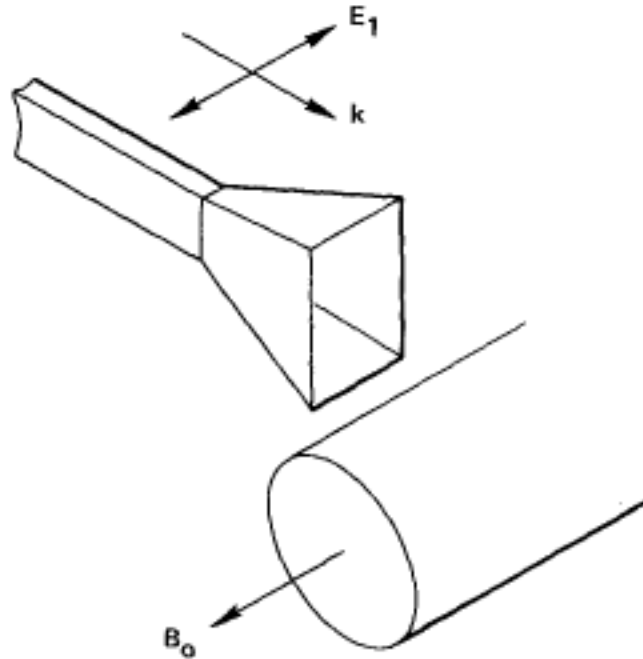
Consider the Ordinary Wave, with  $\mathbf{E}_1$  parallel to  $\mathbf{B}_0$ .  $\mathbf{E}_1$  is parallel to  $\mathbf{B}_0$ , take  $\mathbf{B}_0 = B_0 \mathbf{z}$ ,  $\mathbf{E}_1 = E_1 \mathbf{z}$  and  $\mathbf{k} = k \mathbf{x}$ . e.g. a microwave launcher with a narrow dimension in line with  $\mathbf{B}_0$ . The wave equation is unchanged: for transverse case

$$k^2 \mathbf{E}_1 = i\mu_0 \mathbf{J}_1 + \frac{\partial^2 \mathbf{E}_1}{c^2}$$

We use  $\mathbf{J}_1 = -en\mathbf{u}_1$ . Since  $\mathbf{E}_1 = E_1 \mathbf{z}$  we only need the  $\mathbf{u}_{ez}$  component, given by

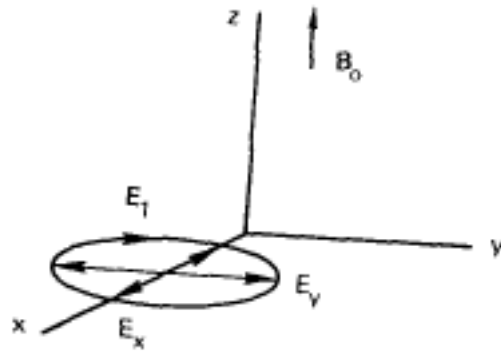
$$m \frac{u_{ez}}{t} = -eE_z.$$

This is the same as for the no- $B$  case, so  $\mathbf{u}_1 = e\mathbf{E}_1 / (im)$  and the results are the same.



**The extraordinary wave**

If  $E_1$  is perp to  $B_0$ , the electron motion will be affected. You might think to take  $E_1 = E_1 y$  and  $k = k$ . But waves with  $E_1$  perp to  $B_0$  tend to be elliptically polarized, not plane polarized, so that as the wave propagates into a plasma it develops a component  $E_x$  along  $k$  allowing  $E_1$  to have x and y components



The E-vector of an extraordinary wave is elliptically polarized. The components  $E_x$  and  $E_y$  oscillate  $90^\circ$  out of phase, so that the total electric field vector  $E_1$  has a tip that moves in an ellipse once in each wave period.

$$E_1 = E_x x + E_y y$$

The linearized equation of motion is (set  $T_e = 0$ , forget subscripts e and 1))

$$-im \mathbf{v}_{e1} = -e[\mathbf{E} + \mathbf{v}_{e1} \times \mathbf{B}]$$

$$v_x = \frac{-ie}{m} [E_x + v_y B_0]$$

$$v_y = \frac{-ie}{m} [E_y + v_x B_0]$$

Solve:

$$v_x = \frac{e}{m} \frac{-iE_x - \frac{c}{\omega} E_y}{1 - \frac{c^2}{\omega^2}}$$

$$v_y = \frac{e}{m} \frac{-iE_y + \frac{c}{\omega} E_x}{1 - \frac{c^2}{\omega^2}}$$

where  $c = eB/(m\omega)$

The wave equation is

$$k^2 \mathbf{E}_1 - (\mathbf{k} \cdot \mathbf{E}_1) \mathbf{k} = i\mu_0 \mathbf{J}_1 + \frac{1}{c^2} \frac{d^2 \mathbf{E}_1}{dt^2} = \frac{i}{c^2} \mathbf{J}_1 + \frac{1}{c^2} \frac{d^2 \mathbf{E}_1}{dt^2}$$

keeping the  $\mathbf{k} \cdot \mathbf{E}_1 = kE_x$  term

$$\left( k^2 - c^2 k^2 \right) \mathbf{E}_1 + c^2 k E_x \mathbf{k} = -\frac{i}{\omega^2} \mathbf{J}_1 = in_0 e \frac{\mathbf{v}_{e1}}{\omega}$$

Separate into components and substitute for v:

$$k^2 E_x = \frac{-i n_0 e}{\omega^2} \frac{e}{m} \frac{iE_x + \frac{c}{\omega} E_y}{1 - \frac{c^2}{\omega^2}}$$

$$\left( k^2 - c^2 k^2 \right) E_y = \frac{-i n_0 e}{\omega^2} \frac{e}{m} \frac{iE_y - \frac{c}{\omega} E_x}{1 - \frac{c^2}{\omega^2}}$$

now use definition of plasma frequency  $\omega_p$

$$p = \sqrt{\frac{n_0 e^2}{m}}$$

$$\left(1 - \frac{c^2 k^2}{2} - \frac{p^2}{p} E_x + \frac{i p^2 c}{p} E_y\right) = 0$$

$$\left(\left(1 - c^2 k^2\right) \left(1 - \frac{c^2}{2} - \frac{p^2}{p} E_y - \frac{i p^2 c}{p} E_x\right)\right) = 0$$

These two simultaneous equations have a solution if

$$\begin{vmatrix} 1 - \frac{c^2}{2} - \frac{p^2}{p} & \frac{i p^2 c}{p} \\ \left(1 - c^2 k^2\right) \left(1 - \frac{c^2}{2} - \frac{p^2}{p} E_y\right) & -\frac{i p^2 c}{p} E_x \end{vmatrix} = 0$$

Define an upper hybrid frequency

$$\omega_H^2 = \omega_p^2 + \omega_c^2$$

which is the frequency of electron waves across a B field. Note that the first element in the determinant is just  $1 - \frac{\omega_p^2}{\omega^2}$ , and the solution is equivalent to

$$\left(1 - \frac{\omega_p^2}{\omega_H^2}\right) \left(1 - \frac{\omega_p^2}{\omega^2} - c^2 k^2\right) \left(1 - \frac{c^2}{2} - \frac{p^2}{p} E_y\right) = \frac{p^2 c}{p} E_x$$

$$\frac{c^2 k^2}{2} = \frac{1 - \frac{\omega_p^2}{\omega_H^2}}{1 - \frac{\omega_p^2}{\omega^2} - \frac{p^2}{p} E_y}$$

Replace the first  $\omega_H^2 = \omega_p^2 + \omega_c^2$  on the RHS, and multiply through by  $1 - \frac{\omega_p^2}{\omega^2}$  to get

$$\frac{c^2 k^2}{2} = \frac{c^2}{V_p^2} = 1 - \frac{\omega_p^2}{\omega^2} \frac{1 - \frac{\omega_p^2}{\omega_H^2}}{1 - \frac{\omega_p^2}{\omega^2}}$$

**Cutoffs and resonances.**

Cutoff when index of refraction = 0, i.e. when  $\omega = \omega_c$  infinity, or  $k = 0$ , as index of refraction =  $ck/\omega$ . A resonance occur when the index of refraction becomes infinite, or when  $\omega = \omega_p$ .

So resonance of X mode when  $k = \text{infinity}$ , and

$$\omega_H^2 = \omega_p^2 + \omega_c^2 = \omega^2$$

As a wave of given  $\omega$  approaches this point, its phase velocity and group velocity approach zero and the wave energy is converted to upper hybrid oscillations. The X mode, which was electromagnetic and electrostatic, becomes an electrostatic oscillation.

The cutoff is found when  $k = 0$  as

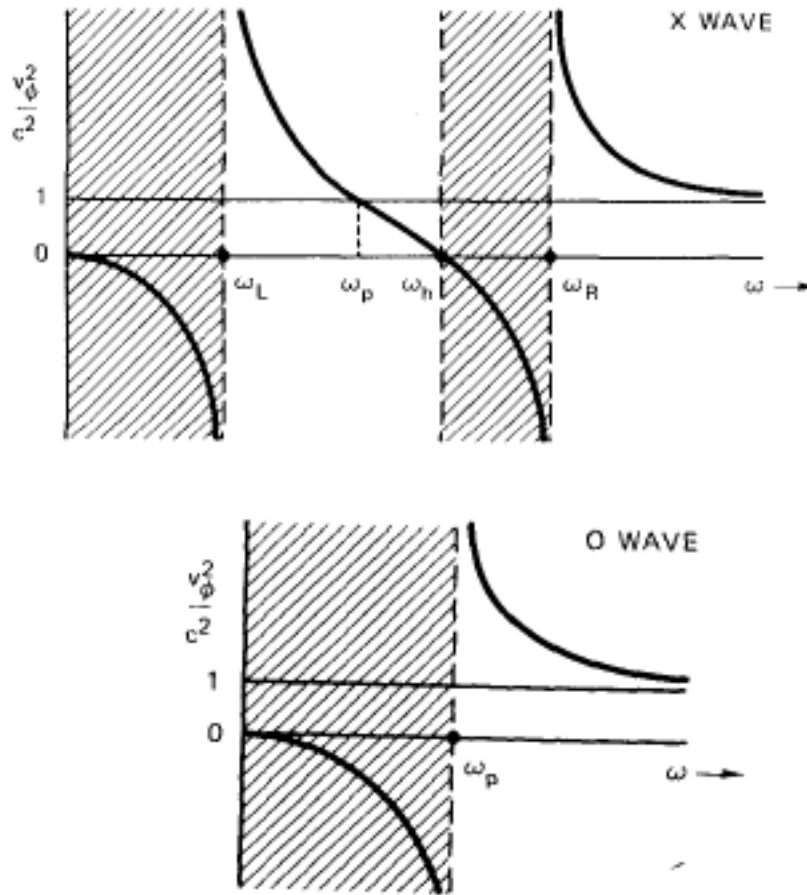
$$\begin{aligned} 1 &= \frac{\omega_p^2}{\omega^2} \frac{\omega^2 - \omega_c^2}{\omega^2 - \omega_H^2} = \frac{\omega_p^2}{\omega^2} \frac{1}{\left(\omega^2 - \omega_H^2\right) / \left(\omega^2 - \omega_p^2\right)} \\ &= \frac{\omega_p^2}{\omega^2} \frac{1}{1 - \frac{\omega_c^2}{\left(\omega^2 - \omega_p^2\right)}} \\ 1 - \frac{\omega_c^2}{\left(\omega^2 - \omega_p^2\right)} &= \frac{\omega_p^2}{\omega^2} \\ 1 - \frac{\omega_p^2}{\omega^2} &= \frac{-\omega_c^2}{\omega^2 - \omega_p^2} \\ 1 - \frac{\omega_p^2}{\omega^2} &= \frac{\omega_c^2}{\omega^2 - \omega_p^2} \\ 1 - \frac{\omega_p^2}{\omega^2} &= \pm \frac{\omega_c}{\omega} \\ \omega^2 \mp \omega_c^2 - \omega_p^2 &= 0 \end{aligned}$$

two cutoff's, the left hand and right had (see pictures later)

$$\begin{aligned} \omega_R &= \frac{1}{2} \left[ \omega_c + \sqrt{\omega_c^2 + 4\omega_p^2} \right] \\ \omega_L &= \frac{1}{2} \left[ -\omega_c + \sqrt{\omega_c^2 + 4\omega_p^2} \right] \end{aligned}$$

Plot  $\omega^2 / (c^2 k^2) = 1/\mu^2$  (1/(refractive index)) against frequency. Imagine  $\omega_c$  fixed, and wave of fixed  $\omega$  enters plasma from outside. As wave enters regions of higher density, the frequencies  $\omega_L$ ,  $\omega_p$ ,  $\omega_H$  and  $\omega_R$  will increase (moving to the right). This is the same as if the density was fixed, and the frequency gradually decreases. So at large  $\omega$  (low n)  $v_p$  approaches c.  $v_p$  increases until the RH cutoff (hence RH) at  $\omega = \omega_R$ . There  $v_p$  is infinite. Between  $\omega = \omega_R$  and  $\omega = \omega_H$ ,  $\omega^2/k^2$  is negative and there is no propagation. at  $\omega = \omega_H$  there is a resonance, and  $v_p = 0$ . Between  $\omega = \omega_H$  and  $\omega = \omega_L$  propagation is possible, and the wave travels either  $>$  or  $<$  c

depending on whether  $\epsilon$  is  $<$  or  $>$   $\epsilon_p$ . at  $\epsilon = \epsilon_p$  the wave travels at  $c$ . There is another region of no propagation for  $\epsilon < \epsilon_L$ .



### General em waves in plasmas

See previous analysis for

$$\nabla \times (\nabla \times \mathbf{E}) = \mu_0 \mathbf{j} + \frac{\ddot{\mathbf{E}}}{c^2}$$

Will Fourier analyze assuming wave field are small enough that the current is a linear function of the electric field. Then we write e.g.

$$\mathbf{E}(\mathbf{x}, t) = \int \mathbf{E}(\mathbf{k}, \omega) e^{i(\mathbf{k} \cdot \mathbf{x} - \omega t)} d^3k d\omega$$

and treat each Fourier mode  $\mathbf{E}(\mathbf{k}, \omega)$  as separate.. We assume an Ohm's law

$$\mathbf{j}(\mathbf{k}, \omega) = \hat{\sigma}(\mathbf{k}, \omega) \cdot \mathbf{E}(\mathbf{k}, \omega)$$

with  $\hat{\sigma}$  the conductivity tensor. For a single Fourier mode we have

$$\mathbf{k} \times (\mathbf{k} \times \mathbf{E}) + i (\mu_0 \boldsymbol{\cdot} \mathbf{E} - \epsilon_0 \mu_0 i \mathbf{E}) = 0$$

i.e.

$$\mathbf{k}\mathbf{k} - k^2 \mathbf{i} + \frac{\epsilon_0 \mu_0}{c^2} \boldsymbol{\cdot} \mathbf{E} = 0 \tag{a)}$$

$$= \mathbf{1} + \frac{i}{\epsilon_0}$$

where  $\mathbf{i}$  is the unit dyadic and  $\boldsymbol{\cdot}$  the dielectric tensor. This represents three simultaneous homogeneous equations, and to have a non zero solution we require the determinant be zero

$$\text{Det } \mathbf{k}\mathbf{k} - k^2 \mathbf{i} + \frac{\epsilon_0 \mu_0}{c^2} \boldsymbol{\cdot} = 0$$

This is the dispersion relationship. The propagation of equation a) is a matrix eigenvalue problem. The eigenvalue (which makes the determinant zero) gives the dispersion relationship, while the eigenvector  $\mathbf{E}$  corresponds to a certain eigenvalue. The simplest case is for an isotropic medium when  $\boldsymbol{\cdot} = \mathbf{1}$  and  $\epsilon_0 = \epsilon_0 \mathbf{1}$ . Then we can separate the wave into two types, one where the  $\mathbf{E}$  polarization is transverse ( $\mathbf{k} \cdot \mathbf{E} = 0$ ) and one where the  $\mathbf{E}$  polarization is longitudinal ( $\mathbf{k} \times \mathbf{E} = 0$ ) to the propagation direction. Taking  $\mathbf{k}$  along the z axis we have

$$\mathbf{k}\mathbf{k} - k^2 \mathbf{i} + \frac{\epsilon_0 \mu_0}{c^2} \boldsymbol{\cdot} = \begin{pmatrix} -k^2 + \frac{\epsilon_0 \mu_0}{c^2} & 0 & 0 \\ 0 & -k^2 + \frac{\epsilon_0 \mu_0}{c^2} & 0 \\ 0 & 0 & \frac{\epsilon_0 \mu_0}{c^2} \end{pmatrix}$$

The determinant = 0 when

$$-k^2 + \frac{\epsilon_0 \mu_0}{c^2} = 0 \quad \mathbf{E} \text{ transverse}$$

$$\frac{\epsilon_0 \mu_0}{c^2} = 0 \quad \mathbf{E} \text{ longitudinal}$$

The transverse dispersion is the familiar  $\mu = kc/\omega = 1/2$  (optics). The longitudinal dispersion is  $\omega = 0$ , which can be non trivial. When  $\boldsymbol{\cdot}$  is anisotropy there is no simple division into transverse and longitudinal. Choosing  $\mathbf{k}$  along z, the matrix will have non zero off diagonal terms arising from those of  $\boldsymbol{\cdot}$ . If these terms contain explicit  $k$  dependence, the determinant will be quadratic

in  $k^2$ , and there will generally be two solutions for  $k^2$  for a given  $\omega$ . These correspond to the transverse waves of the isotropic case.

To obtain the plasma conductivity consider a single electron. Consider only the effects of the wave field, including a static  $B_0$  but ignoring collisions. This cold plasma approximation (we have assumed thermal velocities can be ignored wrt  $v_p$ , which is  $\ll c$ )

$$m_e \frac{d\mathbf{v}}{dt} = -e(\mathbf{E} + \mathbf{v} \times \mathbf{B}_0)$$

The three components are

$$\begin{aligned} -m_e i \omega v_x &= -eE_x - eB_0 v_y \\ -m_e i \omega v_y &= -eE_y + eB_0 v_x \\ -m_e i \omega v_z &= -eE_z \end{aligned}$$

These can be solved to give

$$\begin{aligned} v_x &= \frac{-ie}{m_e} \frac{1}{1 - \omega^2 / \omega_c^2} E_x - i \frac{\omega}{\omega_c} E_y \\ v_y &= \frac{-ie}{m_e} \frac{1}{1 - \omega^2 / \omega_c^2} i E_x + E_y \\ v_z &= \frac{-ie}{m_e} E_z \end{aligned}$$

where  $\omega_c = eB_0/m_e$  is the electron cyclotron frequency. All the electrons move the same, and the current density is

$$\mathbf{j} = en_e \mathbf{v} = \hat{\sigma} \cdot \mathbf{E}$$

and the conductivity tensor is

$$\hat{\sigma} = \frac{in_e e^2}{m_e} \begin{pmatrix} 1 & -i\frac{\omega}{\omega_c} & 0 \\ i\frac{\omega}{\omega_c} & 1 & 0 \\ 0 & 0 & 1 - \omega^2 / \omega_p^2 \end{pmatrix}$$

The ions can be treated the same. The total is approximately equal to the electron value as  $m_e \ll m_i$  as long as the frequencies are high enough.

the dielectric tensor  $\hat{\epsilon} = \mathbf{1} + \frac{i}{\omega} \hat{\sigma}$  becomes



$$\begin{aligned}
 & 1 - \frac{\omega_p^2}{\omega^2 - \omega_c^2} - \frac{i \omega_p^2}{\omega(\omega^2 - \omega_c^2)} = 0 \\
 & = \frac{-i \omega_p^2}{\omega(\omega^2 - \omega_c^2)} \left( 1 - \frac{\omega_p^2}{\omega^2 - \omega_c^2} \right) = 0 \\
 & \qquad \qquad \qquad 0 \qquad \qquad \qquad 0 \qquad \qquad \qquad 1 - \frac{\omega_p^2}{\omega^2}
 \end{aligned}$$

where the plasma frequency  $\omega_p = \sqrt{n_e e^2 / (\epsilon_0 m_e)}$ . The standard practice is to use

$$X = \omega_p^2 / \omega^2 \quad Y = \omega_c / \omega \quad N \text{ or } \mu = kc / \omega$$

Then substitute into Det  $\mathbf{k} \mathbf{k} - k^2 \mathbf{i} + \frac{\omega_p^2}{c^2} = 0$ , choosing axis so that  $k_x = 0$

$$\mathbf{k} = k (0, \sin \theta, \cos \theta)$$

and  $\theta$  is the angle between  $\mathbf{k}$  and  $\mathbf{B}_0$ . The equation for the determinant becomes

$$= \begin{vmatrix} -N^2 + 1 - \frac{X}{1-Y^2} & \frac{iXY}{1-Y^2} & 0 \\ \frac{-iXY}{1-Y^2} & -N^2 \cos^2 \theta + 1 - \frac{X}{1-Y^2} & N^2 \sin \theta \cos \theta \\ 0 & N^2 \sin \theta \cos \theta & -N^2 \sin^2 \theta + 1 - X \end{vmatrix} = 0$$

That is, in the cold plasma approximation  $N^2$  is independent of  $\mathbf{k}$ , and the dispersion relationship is a quadratic for  $N^2$ . The solutions are called the Appleton-Hartree formula for the refractive index:

$$N^2 = 1 - \frac{X(1-X)}{1 - X - \frac{1}{2} Y^2 \sin^2 \theta \pm \frac{1}{2} Y^2 \sin^2 \theta + (1-X)^2 Y^2 \cos^2 \theta}^{1/2}$$

Parallel (to  $B$ ) propagation ( $\theta = 0$ ):

$$N^2 = 1 - \frac{X}{1 \pm Y}$$

and the characteristic polarization of the wave electric field is

$$\frac{E_x}{E_y} = \pm i; \quad E_z = 0$$

This is circularly polarized waves with left and right handed E rotations

Perpendicular (to B) propagation ( $\theta = \pi/2$ )

$$N^2 = 1 - X \quad \text{or} \quad N^2 = 1 - \frac{X(1 - X)}{1 - X - Y^2}$$

with characteristic polarization

$$E_x = E_y = 0$$

$$\frac{E_x}{E_y} = -i \frac{1 - X - Y^2}{XY}; \quad E_z = 0$$

## Electron density measurements in the earth's ionosphere.

Waves entering ionized medium at an angle are described by Snell's law for optics. Consider a plane wave front entering an ionized medium with refractive index  $\mu_r$  from a medium with refractive index  $\mu_i$ . If in the ionized medium the electron density increases with distance into the medium (e.g. height) then the phase velocity increases with distance, so the wave front is bent. The wave will ultimately turn around. Let  $i$  be angle of incidence and  $r$  be angle of refraction

$$\mu_i \sin i = \mu_r \sin r$$

The RHS describes the characteristics of the em wave along the ray path in the plasma.  $\mu_r$  is the refractive index at any point along the plasma path. If the space between transmitter and entrance layer of plasma is assumed to be a vacuum, then  $\mu_i = 1$ . Total internal reflection occurs when  $r = 90^\circ$ , and  $\sin(i) = \mu_r$ .

Consider the ionosphere. Send vertical waves upwards ( $i = 0$ ). They will be reflected when  $\sin(i) = \mu_r = 0$ , i.e. when the signal frequency equals the local plasma frequency. If the difference in time is measured between transmitting and receiving a signal, the height  $h$  at which the reflection occurred can be calculated. Hence we can get density versus height. But problems with  $B$  fields.

## The Interferometer

Any device in which two or more waves interfere by coherent addition of electric fields. The intensity observed is modulated according to whether the waves interfere constructively or destructively.

Simplest system - two waves with monochromatic fields  $E_1 \exp(i \omega t)$  and  $E_2 \exp(i(\omega t + \phi))$ . Add these two phase-displaced waves and the total field is

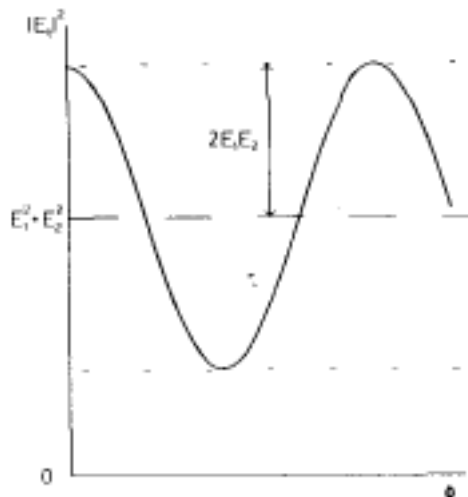
$$E_t = (E_1 + E_2 e^{i\phi}) e^{i\omega t}$$

The power detected by a square law detector is proportional to

$$|E_t|^2 = (E_1^2 + E_2^2) \left[ 1 + \frac{2E_1 E_2}{E_1^2 + E_2^2} \cos \phi \right]$$

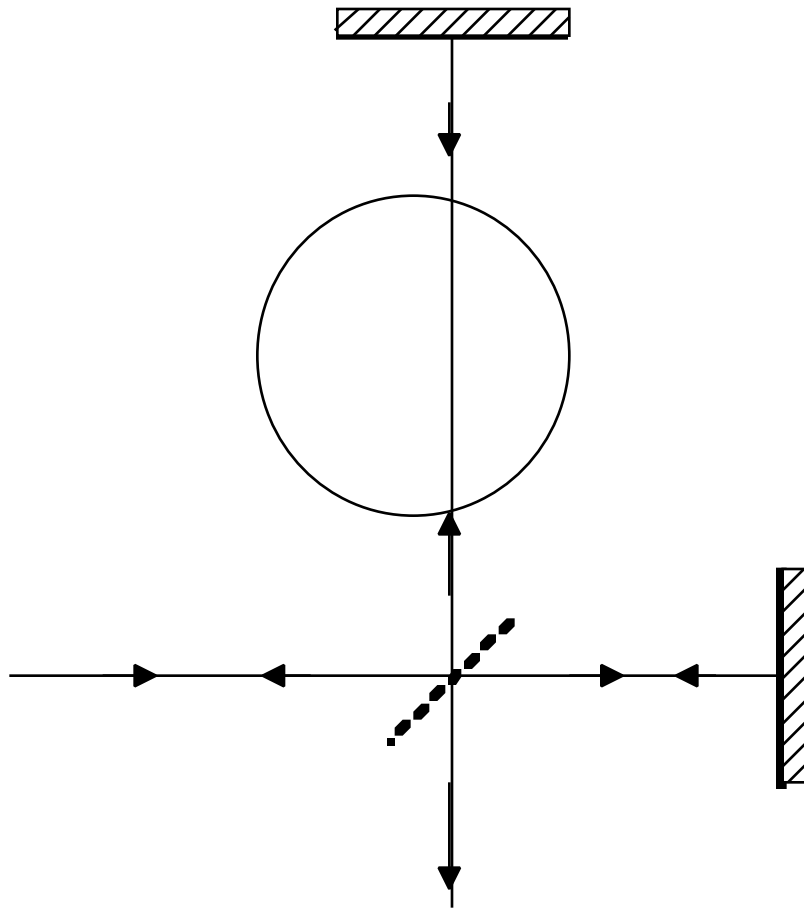
The output intensity (power) has a dependence on the phase- see below.

Fig. 4.1. Variation in the (power) output signal of a two-beam interferometer with relative phase.



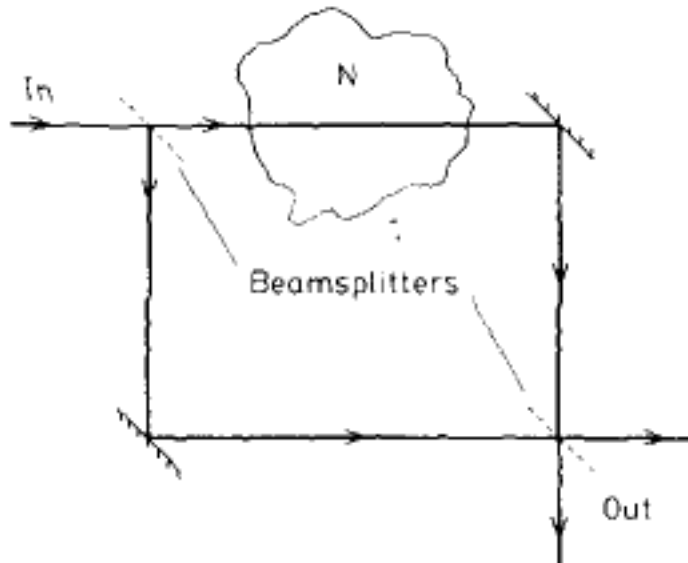
## Michelson Interferometer

A two beam system, with one beam splitter, two arms in which the beams travel in both directions, two outputs, one of which is also along the input. The arms can be straight free space paths or micro wave guides. Beamsplitters may be a partial reflectors or microwave couplers. Phase differences between the two components of one of the output beams arise, by changes in the refractive index in one of the arms.



### Mach Zehnder Interferometer

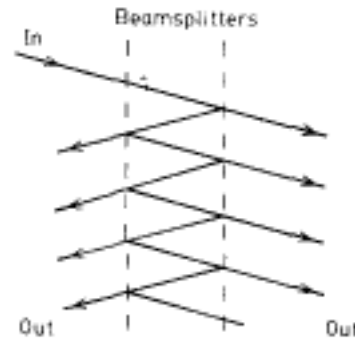
Fig. 4.3. The Mach-Zehnder interferometer configuration.



A two-beam system with two arms in which beams travel only in one direction. Both outputs are separate from the input.

## Fabry Perot Interferometer

Fig. 4.4. The Fabry-Perot interferometer configuration.



A multi-beam interferometer in which there are two beam splitters and two composite output beams. The output is not a simple cos term as in the two arm systems. The phase shift interpretation is more complex, so it is not often used as a plasma refractive index measurement device.

### Simple analysis

Mach Zender system. Assume plasma properties vary slowly. Then locally we can consider the plasma to be made up of slabs of uniform condition. Thus for any frequency and propagation direction there is locally a well defined  $k$  and refractive index  $\mu$  or  $N$ . Wenzel, Kramers and Brillouin are associated with the solution techniques. The propagation of the wave front is expressed as

$$E = e^{i k \cdot dl - t}$$

This is OK as long as the fractional variation of  $k$  in one wavelength is small, so that coupling between waves can be ignored. The phase of the emerging wave is given by

$$= k \cdot dl = \frac{\mu}{c} dl$$

This is the total phase lag in the plasma arm. There is a significant length outside the plasma, and the second arm has a length and lag which may not be known. These problems are removed by comparing the phase difference between the two arms

$$= (k_{plasma} - k_0) dl = (\mu - 1) \frac{dl}{c}$$

(assume  $k_0 = \omega/c$ , i.e. in vacuum). Then use

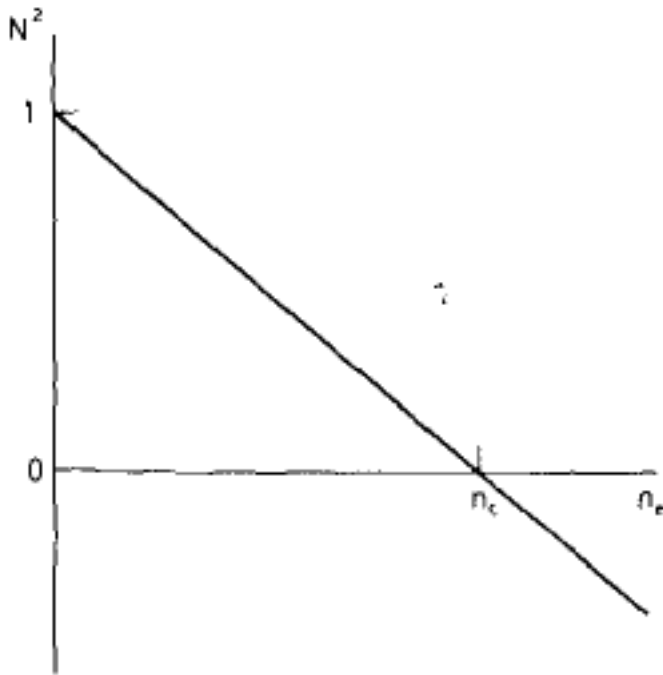
$$\mu = \frac{ck}{\omega} = \sqrt{1 - \frac{\omega_p^2}{\omega^2}} = \sqrt{1 - \frac{n_e}{n_c}}$$

where the cutoff density is

$$n_c = \frac{\omega_p^2}{\omega^2}$$

Plotting  $\mu^2 (= N^2)$  against  $n_e$  gives a straight line - see below

Fig. 4.5. The variation of the square of the refractive index  $N^2$  of the ordinary mode with plasma density.



For  $n_e < n_c$  the interferometer gives us a measure of the density

$$= (\mu - 1) \frac{dl}{c} = \frac{1}{c} (\mu - 1) dl = \frac{1}{c} \left( \sqrt{1 - \frac{n_e}{n_c}} - 1 \right) dl$$

Far from the cutoff we have

$$\frac{1}{2cn_c} n_e dl$$

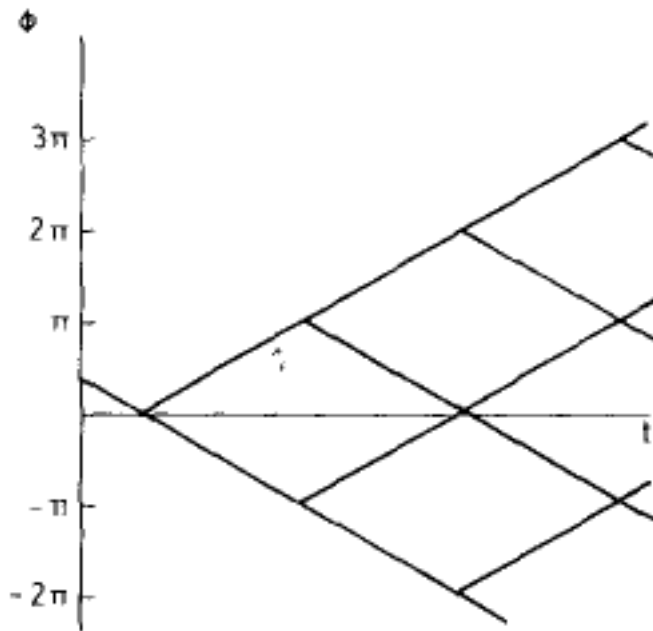
## Determining the phase shift

We need to interpret the output power as measured by a detector in terms of a phase shift..

Problems include

1. Amplitude variations of  $E_1$  and/or  $E_2$  (absorption, refraction)
2. Phase change direction ambiguity. This occurs when  $\dot{\phi} = 0$ ,  $\pi$ ,  $2\pi$ , etc. At these points  $d|E_t|^2/d\phi = 0$ , and there is a null in the phase sensitivity. For a time dependent  $\phi$  it is not possible to tell if there has been a change in the sign of  $d\phi/dt$  at these problem points.

Fig. 4.6. Possible evolution paths of phase that would give identical outputs from a simple interferometer.



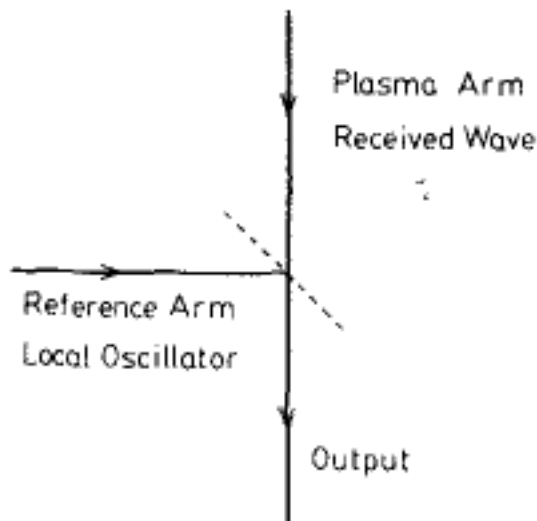
Amplitude variations are alleviated by monitoring both outputs since the total powers in both outputs is equal to the sum of the powers in the interferometer arms. The second problem requires an additional output whose power is proportional to  $\sin \phi$  (instead of  $\cos \phi$ ). That is, it requires a second output in quadrature with the first. This could be done by providing a second interferometer with a phase  $\pi/2$  along the same path as the first. The usual solution is to modulate the interferometer phase. Then the interferometer is effectively reading  $\cos$  and  $\sin$  functions, and this must be done faster than variation in  $\phi$  occur.

A wave frequency is the rate of change of phase. This variations in phase can be as variations in frequency. Phase modulation is equivalent to frequency modulation, and the problem is similar to FM detection.

Look at the final beam splitter, where the two waves are mixed. One wave has been phase, or equivalently frequency, modulated by the plasma arm ( $\omega_2$ ). The reference arm ( $\omega_1$ ) is a local oscillator in the detection of the received wave. The output contains sum and difference frequencies: of interest is the low frequency  $\omega = \omega_2 - \omega_1$ .

If there is no density change (subscript 0) then  $\omega_2 = \omega_1$  and  $\omega = 0$ . Now let the phase change and the output frequency  $\omega \neq 0$ . But both positive and negative  $\omega$  give an output frequency  $|\omega|$ , so there is an ambiguity. Introduce an extra phase modulation. Then even when the plasma phase shift is constant the frequencies  $\omega_2 = \omega_1$ . Then the output contains  $\omega = \omega_2 - \omega_1$  (take as constant). The final mixer acts as a heterodyne receiver with an intermediate frequency  $\omega$  (instead of a homodyne receiver with  $\omega = 0$ ), and the output signal  $s$  at a frequency  $\omega = \omega_0 + d\phi/dt$

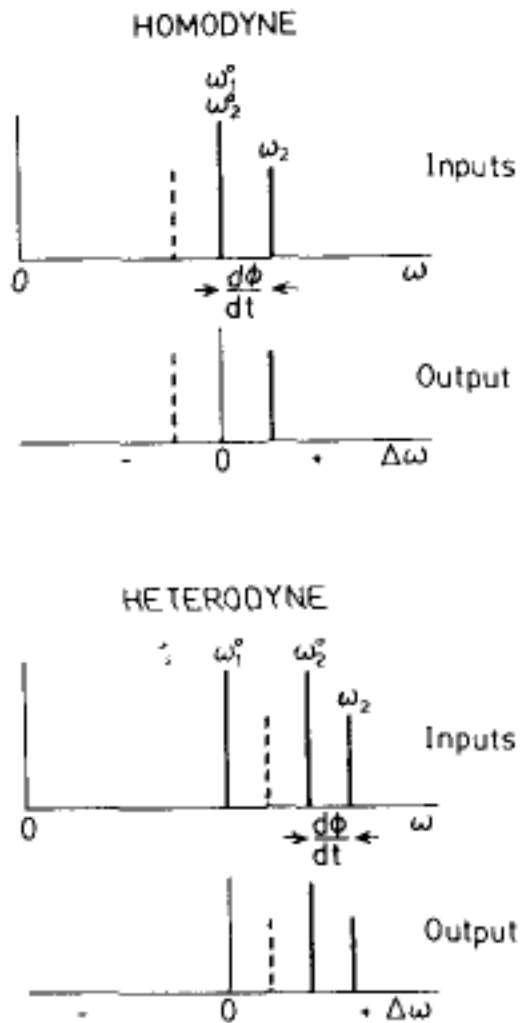
Fig. 4.7. The final beamsplitter of an interferometer can be regarded as a mixer in a heterodyne receiver.





The output frequency thus increases or decreases according to the direction of the phase change, and "problem solved".

Fig. 4.8. Illustration of the frequency relationships in homodyne and heterodyne reception.



## Modulation and Detection

1. Mechanical modulation - insert a rotating wheel into one of the arms. The wheel has a diffraction grating cut into its rim to optimize reflection. Doppler shifts:

$$= \frac{1 + v_i/c}{1 - v_r/c}$$

$v_i, v_r$  are the components of wheel velocity along incident and reflected paths.

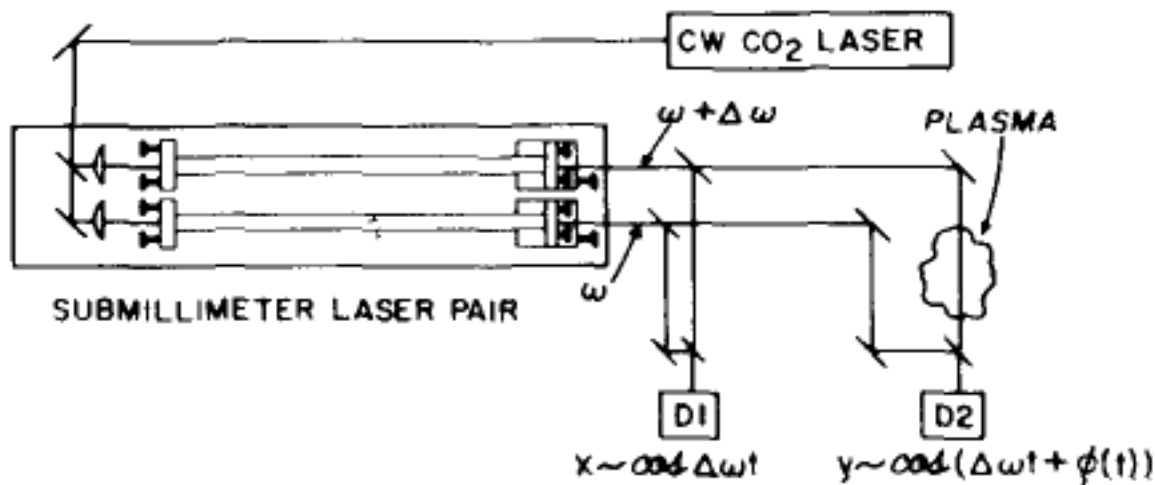
2. Sweep source frequency. If one arm is much longer than the other, the frequency of the waves when they interfere, are different by

$$\dot{\phi} = \frac{d}{dt} \frac{L}{v_p}$$

$L$  is difference in arm length,  $v_p$  is radiation phase velocity ( $= c$ ),  $d/dt$  is sweep rate

3. Use two different sources. Need  $\Delta\omega$  very small.

Fig. 4.10. Schematic of a dual-laser heterodyne interferometer [after Wolfe et al (1976)].



Finally, count number of periods of the IF beat frequency and subtract from it  $2\phi(t)$  (what would be seen if there is no phase change).

### Coherence, diffraction, refraction.

The frequency used depends on density to be probed. For  $n_e = 10^{17}$  to  $10^{21} \text{ m}^{-3}$  then plasma frequency from 3 to 300 GHz, and wavelengths from 100 to 1 mm. Need almost coherent beams (narrow bandwidths) because contributions to output power from different frequencies must all experience the same phase shift, or the degree of modulation of the output power caused by phase changes (the phase contrast) will be decreased (random phase additions will occur). Coherent waves follow Gaussian optics: (spatial eigenmodes of the beam), and are diffraction limited, so that angular divergence and beam size are uniquely related through diffraction.

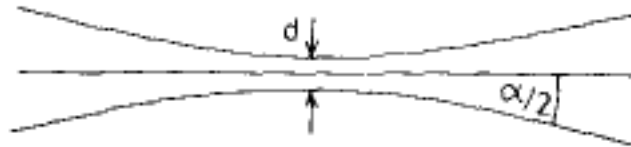
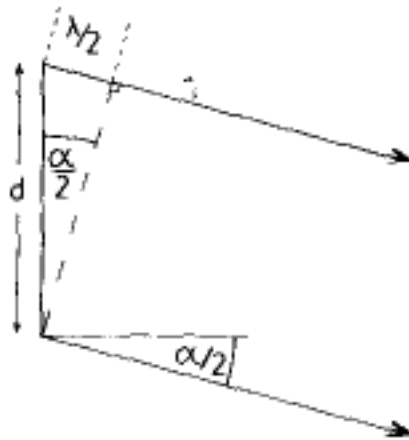


Fig. 4.11. Diffraction-limited beam focus.

Bring a diffraction limited beam to a focus. The angular half width far from focus (Fraunhofer limit) is given by the condition that the difference in path length across the wave front is about  $\lambda/2$ , and  $\Delta L = d \sin(\alpha/2)$ . Huygens wavelets add up in phase.

Fig. 4.12. Diffraction angle determined by a Huygens construction.



At the detector we need signals to be coherent in space: we need alignment and wave fronts to be parallel. In examples a) wave fronts not parallel, and b) misaligned. These are equivalent, and contrast will be lost if relative displacement of wave fronts is  $> \lambda/2$ , equivalent to an angular deviation of beam directions of  $\Delta \theta = (\lambda/2 d)$  - the diffraction limited size. Therefore condition for parallel wave fronts is the same as the condition for far-field beams to overlap.

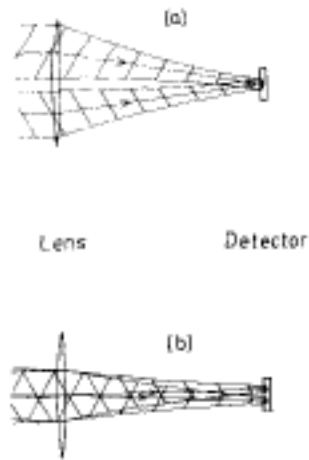


Fig. 4.13. Possible types of interferometer misalignment.

Take adequate alignment without plasma. Refraction moves beam from path. Wave front emerging will have an angle wrt incident wave front. Assume total phase difference along path varies uniformly across beam

$$= \frac{d}{dy} \frac{1}{2} = \frac{d}{dy} \mu dl$$

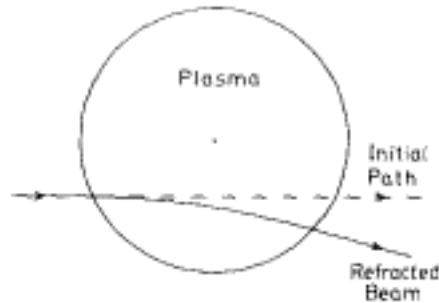
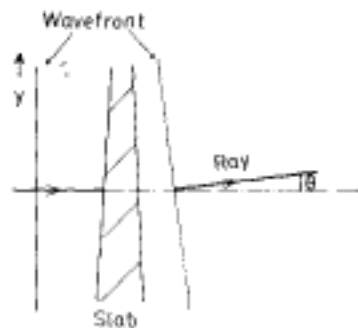


Fig. 4.14. Refraction of an interferometer beam by a nonuniform plasma.

Fig. 4.15. Slab approach to calculating the refractive ray deviation.



For a beam of dimension  $d$ , coherence is maintained if

$$\lambda > d \frac{d}{dy} = \frac{2}{\lambda} d$$

$$\lambda < \frac{2}{\lambda} d$$

This is just the condition for a diffraction limited beam for the far field beam patterns to overlap.

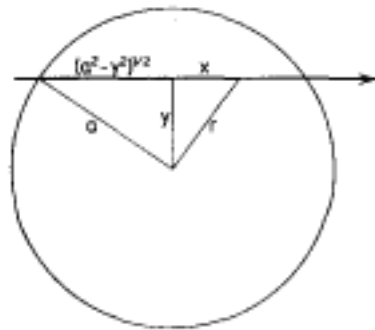
### Frequency choice

minimum: significantly above maximum expected plasma frequency

maximum: mechanical stability of interferometer (angular alignment, stability of path length).  
 Vibration length change  $l$  then phase change is  $2\pi l / \lambda$  - and worse for low  $\lambda$  (high  $f$ ). The phase shift from the plasma  $\Delta\phi$ , so the ratio of spurious vibrational phase error to plasma phase change  $\propto \lambda^{-2}$ .

One can use two interferometers at very different wavelengths to overcome the problem. A very short wavelength mostly measures vibration, while the longer wavelength measures both vibrational and plasma phase shifts.

### Abel Inversion



We must get from line integral to local values. Consider a cylindrical symmetric parameter (e.g. density)  $f(r)$  of which we only know the line integrals

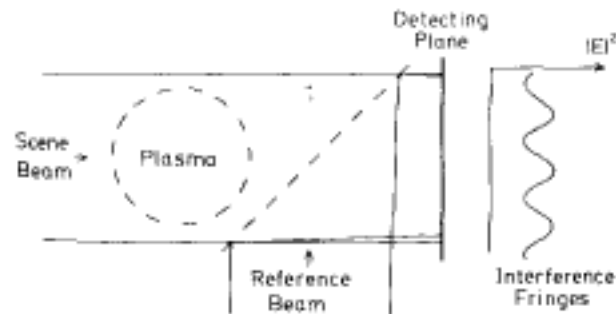
$$F(y) = \int_{-\sqrt{a^2-y^2}}^{\sqrt{a^2-y^2}} f(r) dx = 2 \int_y^a f(r) \frac{r dr}{\sqrt{r^2 - y^2}}$$

(change x integral into an r integral). Studied by Abel:

$$f(r) = -\frac{1}{r} \frac{dF}{dy} \frac{dy}{\sqrt{y^2 - r^2}}$$

## Interference imaging

Fig. 4.16. Deliberate misalignment is used to provide a pattern of reference fringes even in the absence of plasma.



Given intense sources and sensitive detectors, a one or two dimensional interferometric image can be obtained. Usually introduce an initial misalignment to obtain a pattern of linear interference fringes. The plasma induced phase shift moves the position of the fringes to produce a pattern in the image plane, indicating the phase shift. The misalignment is equivalent to spatial modulation instead of temporal in the heterodyne detection systems

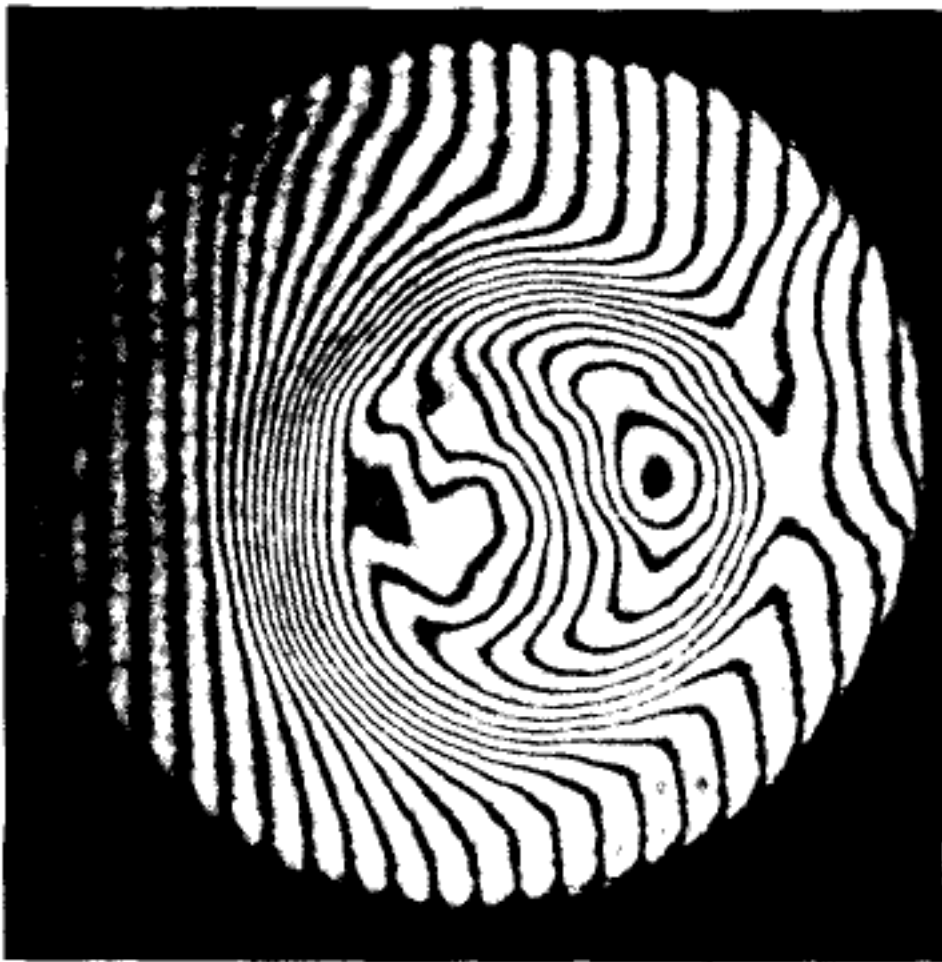
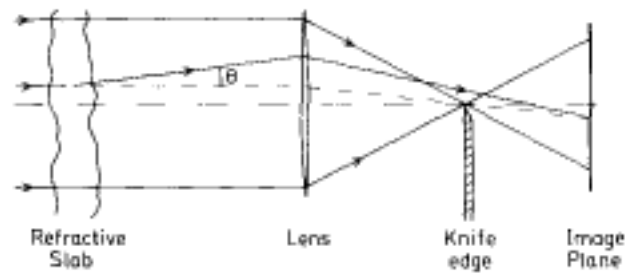


Fig. 4.17. Interferometric image of a  $\theta$  pinch [courtesy F. Jahoda [(1985)] show the circular plasma compressed away from the outer low-density regions in which the fringes are straight.

## Schlieren and Shadowgraphs

Here we rely on the deviation of different paths due to refraction. No reference beam is used. Schlieren are sensitive to the first gradient of refractive index, and shadowgraphs are sensitive to the second.

Fig. 4.18. Principle of the schlieren approach to refractive imaging.



For Schlieren, a plane parallel beam illuminates the plasma, whose thickness  $\ll$  distance to the lens. The ray is deviated by an angle

$$= \frac{d}{dy} \frac{1}{2} = \frac{d}{dy} \mu dl$$

A knife edge at the focal point of the lens partially obstructs the image formed by the undeviated rays. The ray deviation causes the obstruction to increase or decrease depending on the sign of  $\theta$ . The image is not shifted, but the intensity is altered by the variable obstruction of the edge. The change in intensity is proportional to the local value of  $\theta$ .

For Shadograms, the electromagnetic wave energy that would have fallen at  $(x,y)$  is moved to  $(x',y')$ , where e.g.  $y = y + L \theta$  ( $y$ ), and as before

$$= \frac{d}{dy} \frac{1}{2} = \frac{d}{dy} \mu dl$$

Then

$$(x', y') = (x + L \frac{d}{dx} \mu dl, y + L \frac{d}{dy} \mu dl)$$

For a beam of uniform intensity  $I_i$  the detected intensity will be

$$I_d dx' dy' = I_i dx dy$$

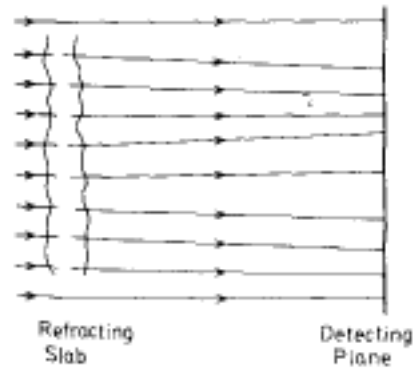
so that

$$\frac{I_i}{I_d} = 1 + L \left( \frac{d^2}{dx^2} + \frac{d^2}{dy^2} \right) \mu dl$$

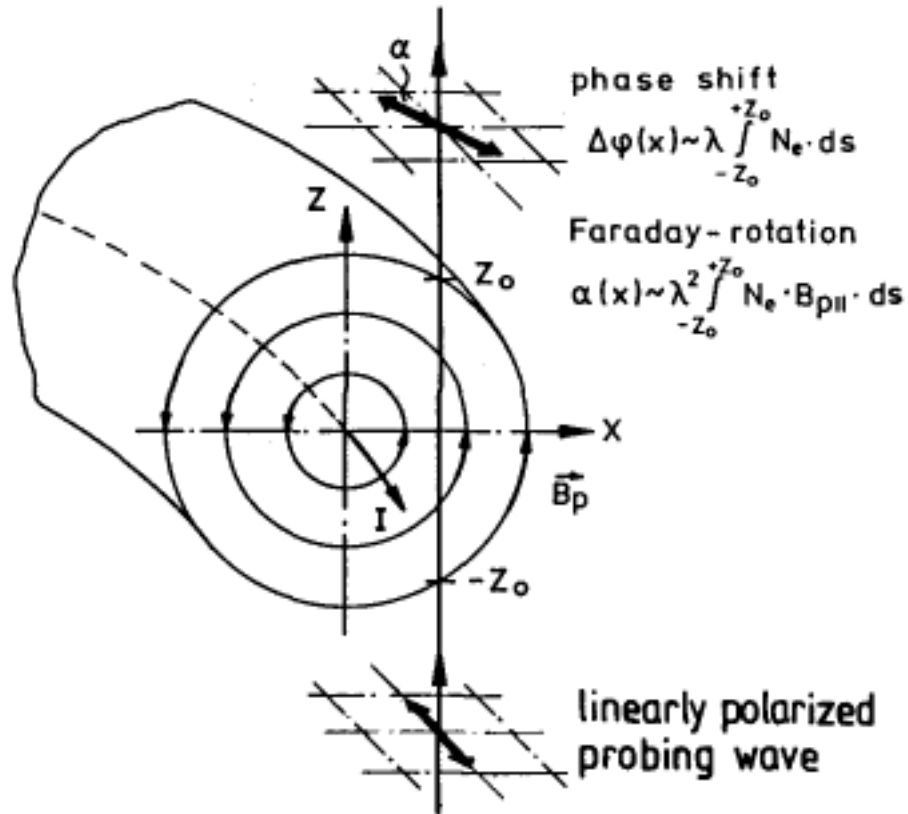
For small intensity deviations  $\frac{I_d}{I} = L \left( \frac{d^2}{dx^2} + \frac{d^2}{dy^2} \right) \mu dl$

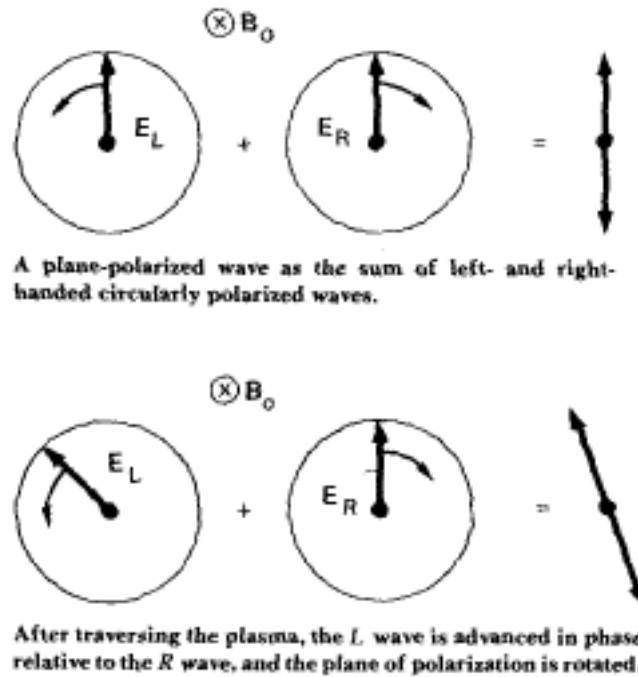


Fig. 4.19. Shadowgraph imaging.



### Faraday rotation





Consider a wave propagating through a medium in which the polarization of the two characteristic modes are circular; so that in a coordinate system with  $k$  along  $z$  the polarization is  $E_x/E_y = \pm i$ . Suppose also that the two characteristic waves have different refractive indices,  $\mu_+$  and  $\mu_-$ . Then to sort out what happens consider the two waves separately, and superimpose the final results. Let the wave be linearly polarized at  $z = 0$  so that  $E_y = 0$  and  $E_x = E$ . Then this is written as

$$E(0) = \frac{E}{2} [(1, -i) + (1, i)]$$

At  $z = 0$  the decomposition is

$$E(z) = \frac{E}{2} [(1, -i)e^{i\mu_+ z/c} + (1, i)e^{i\mu_- z/c}]$$

$$= E \exp i \frac{(\mu_+ + \mu_-)}{2} \frac{z}{c} \cos \frac{(\mu_+ - \mu_-)}{2} \frac{z}{c}, \sin \frac{(\mu_+ - \mu_-)}{2} \frac{z}{c}$$

where

$$= (\mu_+ - \mu_-) \frac{z}{c}$$

is the phase difference of the characteristic waves because of the different refractive indices. Therefore the polarization after  $z$  is rotated an angle of  $\frac{(\mu_+ - \mu_-)z}{2c}$  - the Faraday effect.

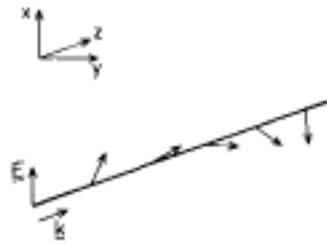


Fig. 4.20. Faraday rotation causes a linearly polarized wave's E vector to rotate as the wave propagates.

At arbitrary angles it is found that, as long as one is not too close to perpendicular, the characteristic polarizations are circular. The Faraday rotation along the beam is

$$= 2.615 \times 10^{-22} \int_L n_e B_{\parallel} dz$$

where  $\theta$  is in  $\mu\text{m}$ ,  $B$  in kG,  $\theta$  in radians,  $L$  in cm.

Fig. 4.21. Coordinate system for expressing the wave polarization.

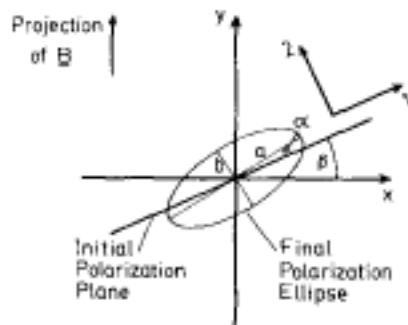
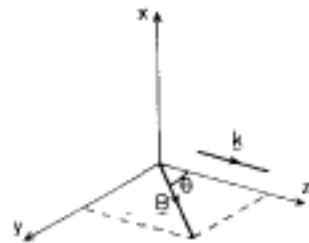


Fig. 4.22. The polarization ellipse and the polarization coordinate systems for the case when propagation is close to perpendicular.

After passing through the plasma the probing beam is both phase shifted and its polarization has become slightly elliptical. The major axis of the vibrational ellipse is rotated by  $\theta$ . The wave is passed through a half wave plate (for calibration). With the optical axis set at  $45^\circ$ , the plate just

interchanges s and p components. The probing beam is then combined with a frequency-offset reference wave at a polarizing beam splitter. The beam splitter is made of tungsten wires parallel to the plane of incidence. Its reflection and transmission properties are such that the p component of an incident wave is split into two p waves of equal amplitude, while the s component is almost completely transmitted. In addition, the reflected and transmitted p components undergo phase shifts of  $3/4$  and  $1/4$ , respectively, while the s component is unaffected. The signal at the polarization detector is a beat signal, with amplitude and phase depending on the intensity of the probe and reference beams and on their polarization parameters. The amplitude is a good measure of the Faraday rotation angle.

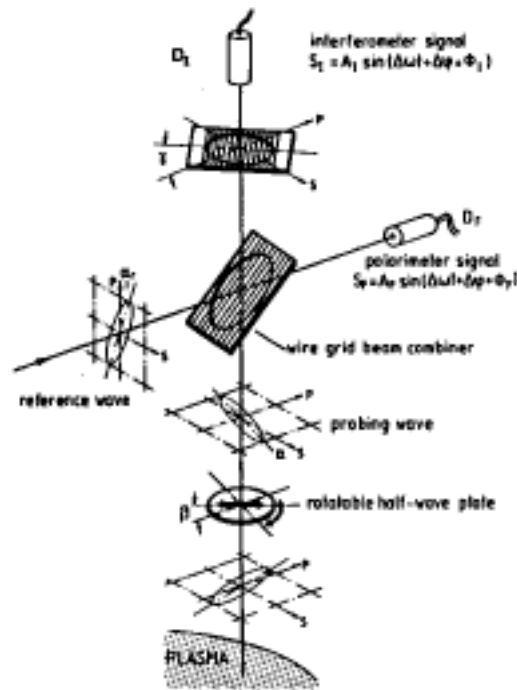


Fig. 4.23. Principle of a heterodyne scheme for simultaneous Faraday rotation interferometry.

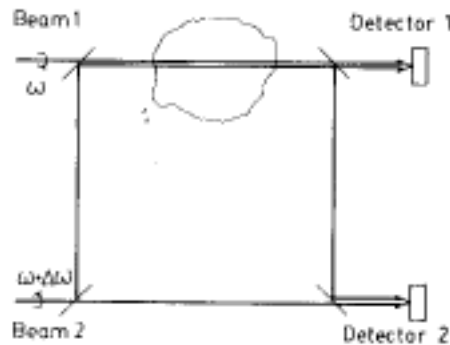
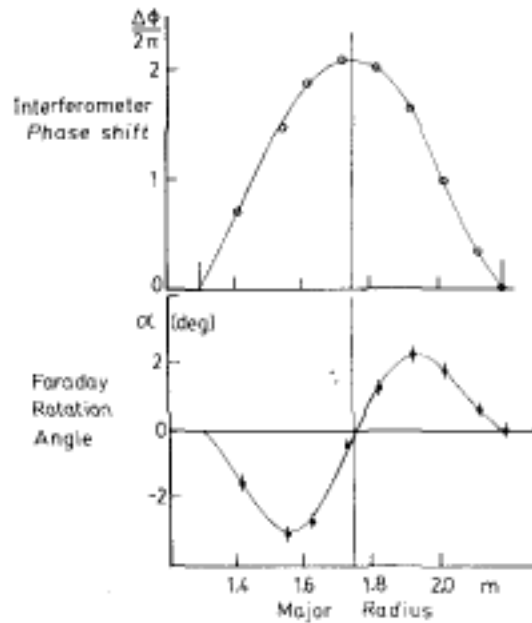


Fig. 4.24. Simultaneous measurements of interferometer phase shift and Faraday rotation angle as a function of chord major radius in the TEXTOR tokamak [after H. Soltwisch (1983)]. The rotation reverses with the direction of the vertical component of the (poloidal) magnetic field. From such data information about the toroidal current density can be obtained.



## Reflectometry

A wave propagating through a plasma of increasing density along the path can arrive at the point where  $k = k_p$ , and reflection occurs at the cut off. Detecting the reflected wave is called reflectometry. It requires  $k < k_p$ , and this is the opposite limit from interferometry.

The objective is to measure the phase change. Note that this is a line integral effect, unlike radar which is a local effect. The phase difference between forward and backward waves is

$$= 2 \int_a^{x_c} \frac{1}{c} \sqrt{k^2 - k_p^2} dx - \frac{\pi}{2}$$

where  $x_c$  is the cutoff location, and  $a$  is the edge. Note the phase change at the cutoff (reflection) point.  $k_p = n_e$ , so the line integral of the density is measured. Different length of travel are measured by changing (sweeping) the frequency.

Note that by differentiating wrt  $\omega$ , substituting the vacuum wavelength  $\lambda = 2\pi c / \omega$  leads to

$$\frac{d}{d\omega} = 2 \frac{dx_c}{cd} \frac{d k_p}{d\omega} \frac{1}{\sqrt{k^2 - k_p^2}}$$

This is the same integral as in Abel's inversion if we let

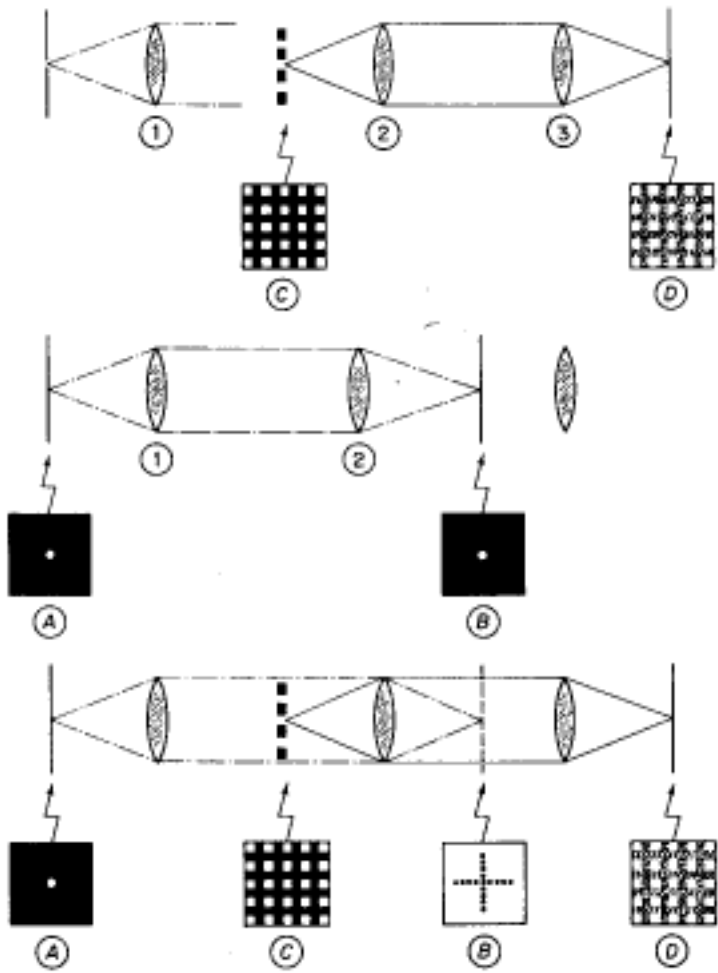
$$y; \quad r; \quad \frac{d}{d_p} \quad F(y); \quad \frac{dx_c}{cd_p} \quad f(r)$$

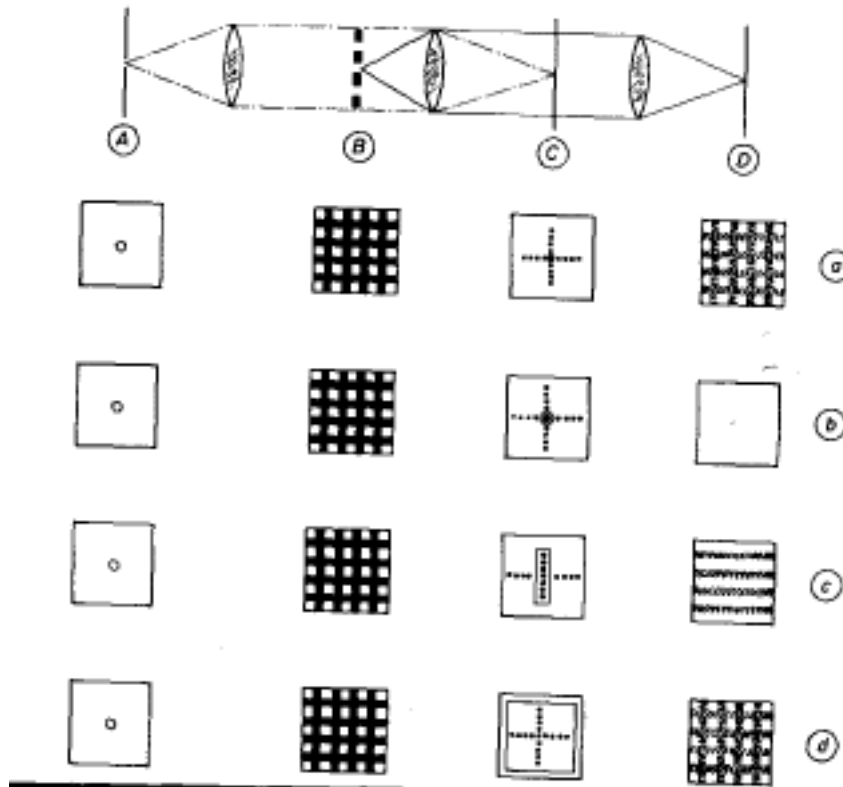
One can deduce the position of the cutoff  $x_c(\omega)$  given  $\omega$  for frequencies below  $\omega_0$ :

$$x_c(\omega) = a + \frac{c}{d} \frac{d}{\sqrt{\omega_0^2 - \omega^2}}$$

## Physical Optics and Fourier Analysis

The two RH lenses 2 and 3 produce a real image D of the real object C, a cross grating. Lenses 1 and 2 project a pinhole diaphragm A into a real image of that diaphragm at B. Together the three lenses perform two independent processes of image formation. Now insert masks in the Fourier transform plane. Planes A and B are conjugate, as are planes C and D. If distances are correctly set, B contains the Fourier transform of the intensity distribution. Insert a mask at B with only a pinhole, (at the place of the zero order) and D will receive light but no information. We have spatial filtering.





Scalar wave equation

$$\nabla^2 V(\mathbf{x}, t) = \frac{1}{c^2} \frac{\partial^2 V(\mathbf{x}, t)}{\partial t^2}$$

$V(\mathbf{x}, t)$  is the optical disturbance. For monochromatic waves

$$V(\mathbf{x}, t) = (\mathbf{x}) e^{i2\pi \nu t}$$

$\mathbf{x} = x\mathbf{i} + y\mathbf{j} + z\mathbf{k}$ ,  $\mathbf{i}$ ,  $\mathbf{j}$  and  $\mathbf{k}$  are unit vectors along the coordinate axis,  $\nu$  is frequency,  $y$  describes spatial variation of amplitude. Substitute into wave equation to get Helmholtz equation

$$\nabla^2 + \frac{2\pi \nu}{c} = 0; \quad \nabla^2 + k^2 = 0$$

Construct a solution as follows

- a) a geometric point of light will give rise to spherical wave emanating in all directions (Huygens)
- b) Helmholtz equation is linear, so we can superpose solutions
- c) An arbitrary wave shape can be represented by a collection of point sources whose strength is the amplitude of the wave at the point. The field at any point in space is a sum of spherical



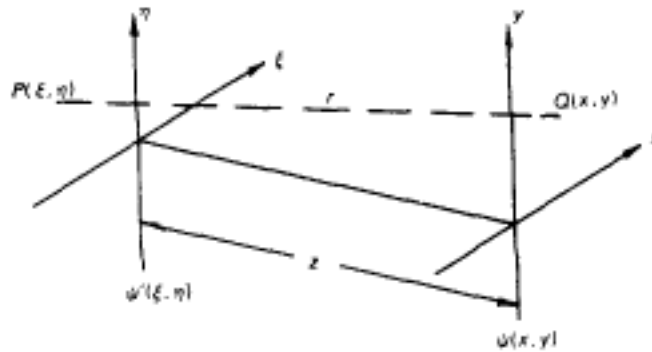
waves. Actually we must allow for a preferred direction (propagation) by including an inclination factor.

Spherical wave described by

$$sp = \frac{e^{\pm ikr}}{r}$$

$r$  is distance from point source to observation point,  $\pm$  indicates converging or diverging waves. If the disturbance across a plane aperture is described by  $\psi(\xi, \eta)$  ( $\xi, \eta$  is position vector in aperture plane) then the Huygens principle development for the field at a point  $\mathbf{x}$  beyond the screen is

$$\psi(\mathbf{x}) = K \int_{aperture} \psi(\xi, \eta) \frac{e^{+ikr(\mathbf{x}, \xi, \eta)}}{r(\mathbf{x}, \xi, \eta)} d\xi d\eta$$



i.e. a spherical wave of amplitude  $\psi(\xi, \eta)$  emanates from each point in the aperture. Note that  $\omega(\mathbf{x}, \xi, \eta)$  is the inclination factor, essentially constant near the axis (a line normal to the aperture plane passing through the center of the aperture). Actually  $\omega(\mathbf{x}, \xi, \eta) = -i \cos(\theta) / (2z)$  where  $\theta$  is the angle between the normal and the direction of propagation at a point. Then with the restriction to the observation point

$$\psi(\mathbf{x}) = \frac{K}{z} \int_{aperture} \psi(\xi, \eta) e^{+ikr(\mathbf{x}, \xi, \eta)} d\xi d\eta$$

The  $r$  in the denominator affects only the amplitude and is slowly varying if  $\xi$  and  $\eta$  are restricted to near the axis. However in the exponent it is important

$$\psi(\mathbf{x}) = \frac{K}{z} \int_{aperture} \psi(\xi, \eta) e^{+ikr(\mathbf{x}, \xi, \eta)} d\xi d\eta$$

Now

$$r(x, y) = [(x - R)^2 + (y - R)^2 + z^2]^{1/2}$$

$$= R \left[ 1 + \frac{x^2 + y^2}{R^2} - \frac{2(x + y)}{R} \right]^{1/2}$$

where  $R^2 = x^2 + y^2 + z^2$ . Now expand for relatively large distances so that

$$r(x, y) = R + \frac{x^2 + y^2}{2R} - \frac{(x + y)}{R} \tag{1}$$

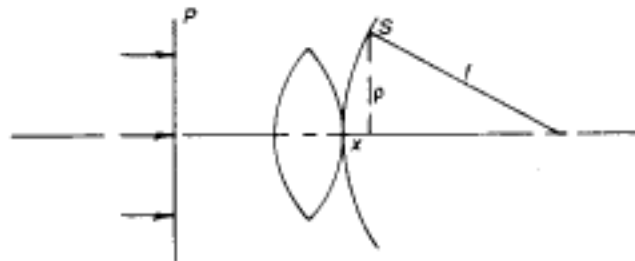
Two cases:

Fraunhofer or far field if the term  $(x^2 + y^2)/(2R)$  can be ignored, Fresnel otherwise

Far field.  $(x^2 + y^2)/(2R)$  is eliminated if  $R$  is increased until  $k(x^2 + y^2)_{\max}/(2R) \ll 1$ . Then, noting  $z^2 \gg x^2 + y^2$ ,

$$U(x, y) = \frac{K e^{-ikz}}{z} \int_{\text{aperture}} U_0(x', y') \exp \left[ \frac{-2i}{z} (x x' + y y') \right] dx' dy' \tag{2}$$

Fraunhofer condition: Place a lens in the  $(x, y)$  plane and observed the diffraction pattern at the focus. A lens is a device which converts a plane wave front into a spherical wave front of radius  $f$ .



P is incident plane wave, S is emerging spherical wave. Now  $(f - x)^2 + p^2 = f^2$  or  $2xf = f^2 - x^2$ . Take  $x$  small, and  $x^2$  ignored, so

$$x = \frac{p^2}{2f}$$

The phase change introduced by the lens is

$$= kx = k \frac{x^2 + y^2}{2f}$$

The lens in the ( , ) plane introduces an additional  $\exp[-ik(\rho^2 + z^2)/(2f)]$  because it produces a spherical converging wave. This term cancels the term  $(\rho^2 + z^2)$  arising from equation 1 when  $f = z$ . The field at the point (x,y) in the focal plane is

$$U(x,y) = \frac{Ke^{-ikf}}{f} \int_{\text{aperture}} U(\rho, \phi) \exp \frac{-2i}{f} (x \rho \cos \phi + y \rho \sin \phi) \rho d\rho d\phi \tag{3}$$

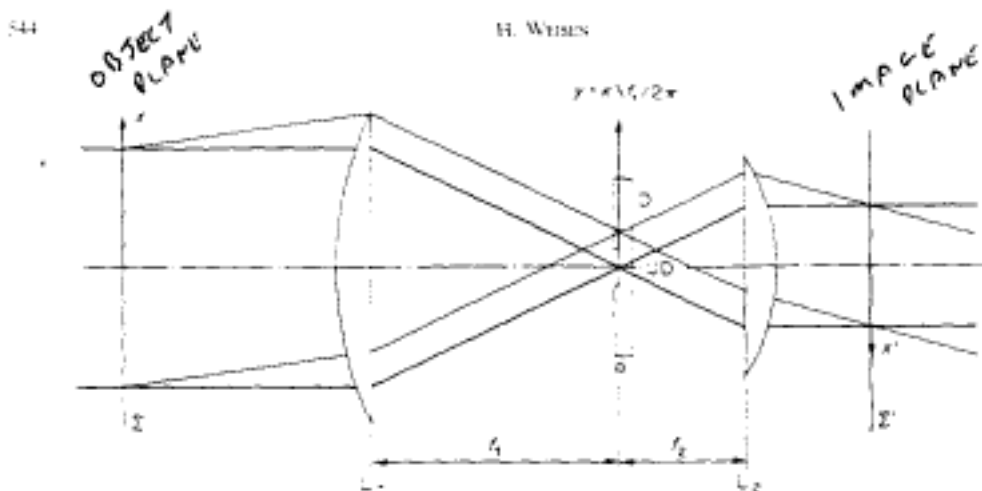
Equations 2 and 3 are identical if  $z = f$ . Thus the field in the far zone or in the focal plane of a lens is the Fourier Transform of the field across the diffracting aperture.

### Phase Contrast Imaging

Electron density fluctuations are traditionally measured by scattering techniques. The scattered radiation is detected in the far field where it is resolved into wavenumber components, or at an image of the scattering volume provided by an optical system. Then the light is spatially, rather than wave number, resolved. When the scale of density fluctuations are sufficiently large, (Raman Nath diffraction), then the effect of the fluctuations on the transmitted wave is described by

$$= \mathbf{k} \cdot d\mathbf{l} = \frac{\mu}{c} dl = k_0 \mu(x,z,t) dl$$

z is along the path length, x is perpendicular to the path length,  $k_0$  is the wave number of the beam in vacuum.. The plasma with its fluctuations acts like a thin phase object, causing small phase changes.



Whereas an interferometer uses a reference beam external to the plasma, phase contrast uses an internal reference. The basic set up is as above. A collimated beam of monochromatic light is

transmitted through the refractive object centered at  $x_0$  and focused by a lens  $L_1$  onto the phase plate (or mirror). The undiffracted (UD) light is focused onto the central depression on P. The diffracted light D (diffracted by the refractive object) intersects the plate beside it. The depth of the depression P (the conjugate area) is designed to introduce a  $\pi/2$  phase shift: the diffracted and undiffracted components have a different phase introduced into them. The lens  $L_2$  recombines the components in the image plane  $x_2$ . The  $\pi/2$  phase shift causes interference between the diffracted and non diffracted components.

For an incident plane wave of unit amplitude the transmitted amplitude can be written as

$$A(x,t) = e^{i\phi(x,t)} [1 + i\psi(x,t)]$$

The amplitude in the focal plane of  $L_1$  is a scaled version of the Fourier transform  $\tilde{A}(k,t)$  of  $A(x,t)$ . with  $k = 2\pi y/f$ ,  $y$  being the distance to the optical axis. Then

$$\tilde{A}(k,t) = \tilde{A}_0(k) + i\tilde{\psi}(k,t)$$

$\tilde{\psi}(k,t)$  is the diffracted part, and ideally the action of the phase plate is to phase shift by  $\pi/2$  without affecting the undiffracted part  $\tilde{A}_0(k)$

$$\tilde{A}^1(k,t) = \tilde{A}_0(k) + \tilde{\psi}(k,t)$$

Lens  $L_2$  performs the inverse Fourier transform

$$A^1(x,t) = 1 + \psi(x,t)$$

The detected signal  $|A^1(x,t)|^2$  contains a term linear in  $\psi(x,t)$ :

$$|A^1(x,t)|^2 = 1 + 2\psi(x,t)$$

i.e.

$$I(x,t) = I_0(x,t)(1 + 2\psi(x,t))$$

where  $I$  and  $I_0$  are the intensities in the presence and absence of the plasma. The conjugate area (slot) must be at least as wide as the focal spot size, and only the diffracted light falling beside it (with a sufficiently large angle of diffraction) will contribute to the intensity. Thus the instrument is a spatial high pass filter.

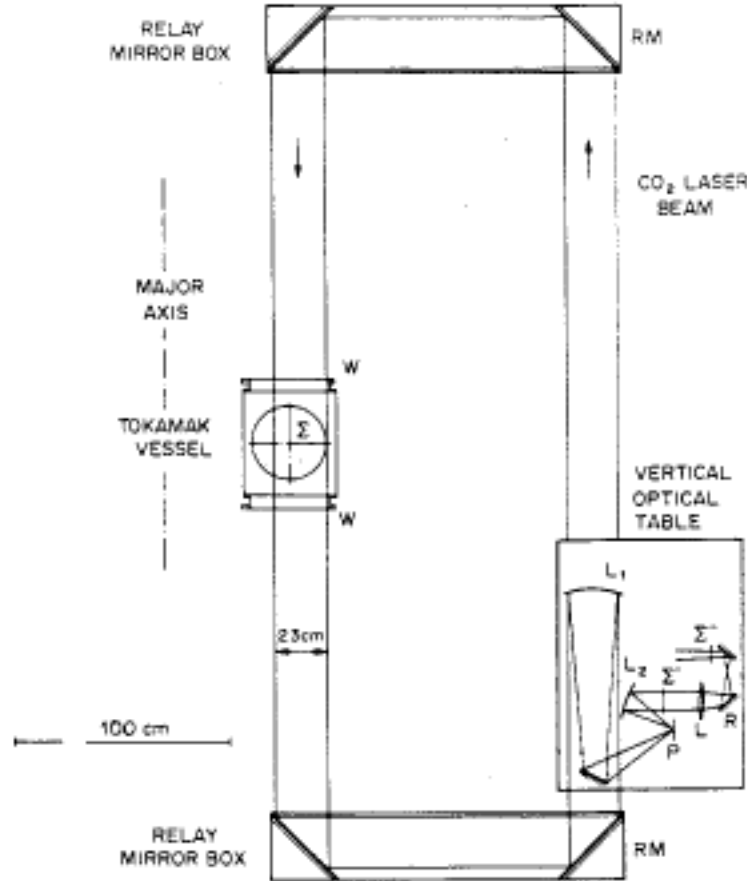


Fig. 2. Experimental setup.  $\Sigma$ , object plane centered on the plasma midplane;  $\Sigma'$  and  $\Sigma''$ , image planes of the plasma; W, NaCl windows; RM, relay mirrors;  $L_1$ , main parabolic mirror; P, phase mirror;  $L_2$ , imaging mirror; L, auxiliary lens; R, rotating mirror. The beam-producing optics on the rear side of the table use a mirror identical to  $L_1$  and a ZnSe expanding lens.